

5/8" x 3/16" GRID

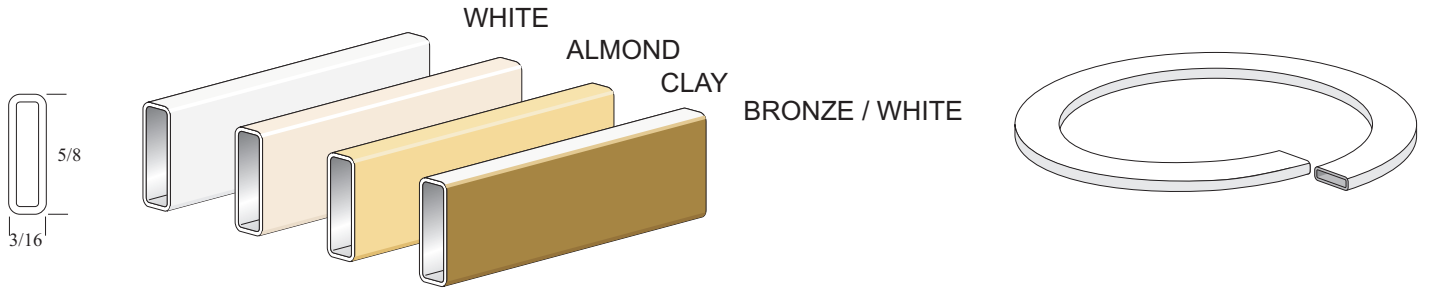

5/8 x 3/16 INTERNAL GRID
 WHT - BI101401 (BI101101)
 ALM - BI101454
 CLAY - BI101451
 BRZ/WHT - BI101492

5/8 x 3/16 INTERNAL GRID ROUNDS
 11.375"D. WHT - BI 259100
 22.75"D. WHT - BI 293501
 22.75"D. ALM - BI 293554
 32.75"D. WHT - BI293401

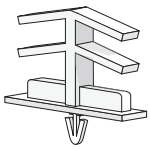

GRID END PIN
 BI101400

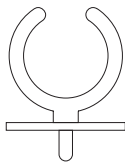

GRID CLIP LOCATOR
 B I 101700

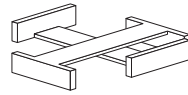

CONCEALED JOINER
 UM300100

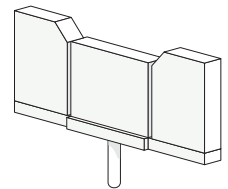

SUNBURST CONNECTOR
 3/16 x 5/8 BI 102800

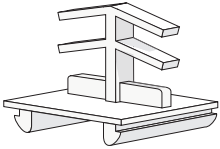

INTERCEPT END PIN
 7/32" BI105700
 11/32" BI221000
 15/32" BI105800
 17/32" BI105900
 19/32" BI106000
 23/32" BI106100
 25/32" BI106200

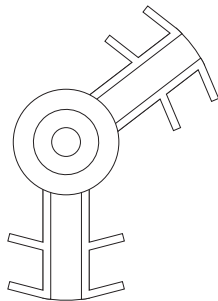

SWIGGLE CONNECTOR
 A- BI 221100
 B- BI 221200

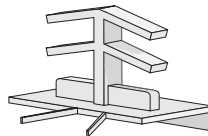

SWIGGLE END PIN
 7/16" BI216000
 11/16" BI219300

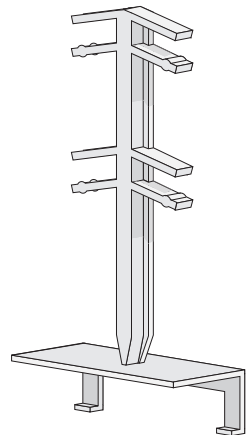

SWIGGLE GRID LOCK CLIP
 7/16" BI221500
 11/16" BI221600

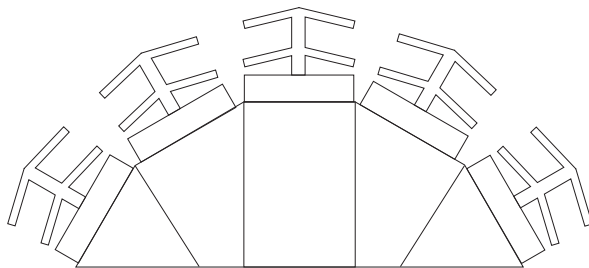

SWIGGLE 5 POS. KEEPER
 3/16 x 5/8
 WHT - BI 101901
 ALM - BI 101954
 CL - BI 101951

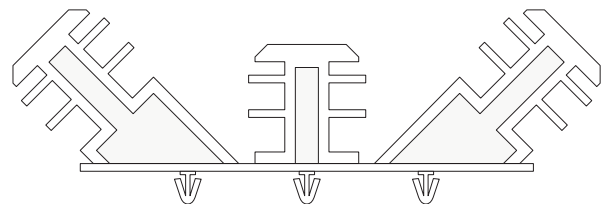

STARBURST SWIGGLE GRID PIN
 3/16 x 5/8 BI 107000

1" CONTOUR GRID

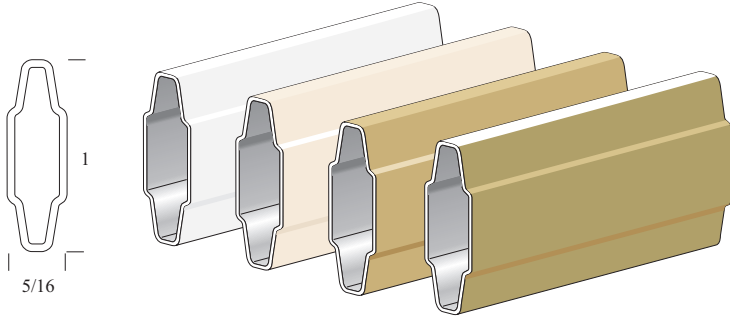

EXTRUDED CONTOUR GRID 8 x 25
 WHT - BI102301 (BI102201)
 ALM - BI102354 (BI102254)
 CLAY - BI102351 (BI102251)
 BRZ/WHT - BI102392 (BI102292)

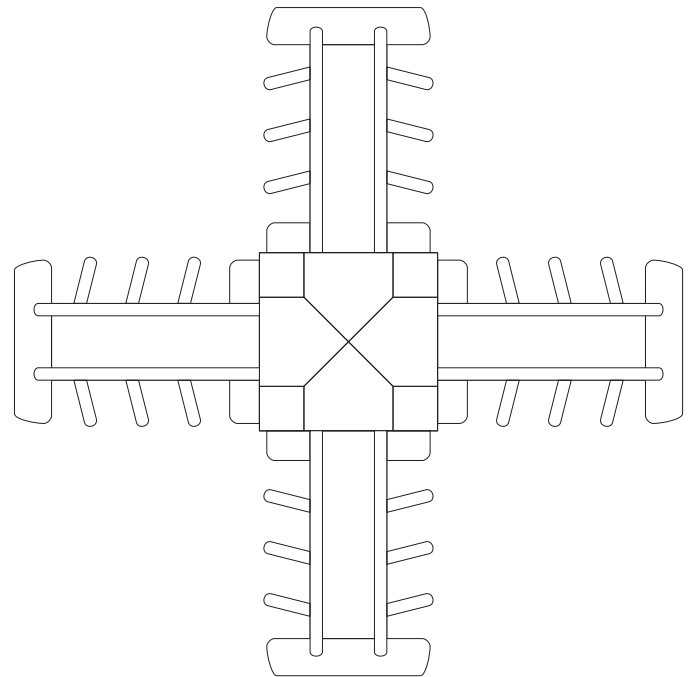

EXTRUDED CONTOUR INTERSECT
 AIRPLANE 8 x 25
 WHT - BI 102501(BI102601)
 ALM - BI 102554
 CL - BI 102551

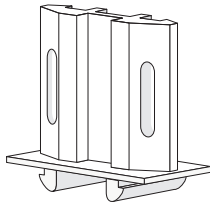

EXTRUDED END PIN
 15/32" BI106300
 17/32" BI106400
 19/32" BI106500
 23/32" BI106900
 25/32" BI106700

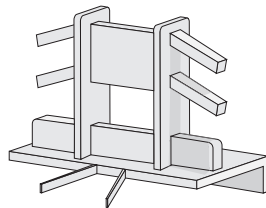

SWIGGLE EXTRUDED
 END PIN 8 x 25
 BI101501

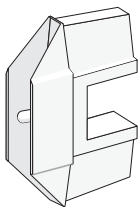

CONTOUR SADDLE CLIP 8 x 25
 WH - BI105401
 ALM - BI105454
 CLAY - BI105451

3/4" CONTOUR GRID

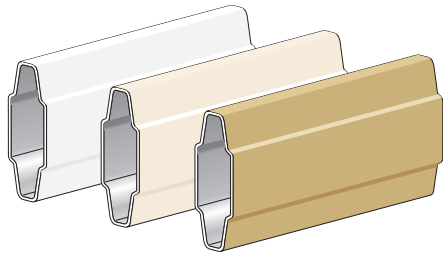
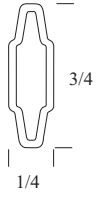

5.5 x 18 CONTOUR GRID
 WHT - BI 267001
 WHT - BI261501
 ALM - BI 267054
 CLAY - BI 267051

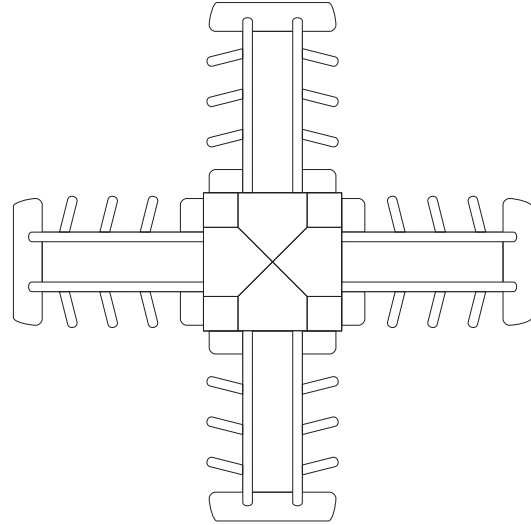

EXTRUDED CONTOUR INTERSECT
AIRPLANE 5.5 x 18
 WHT - BI 279301
 ALM - BI 279354
 CL - BI 279351

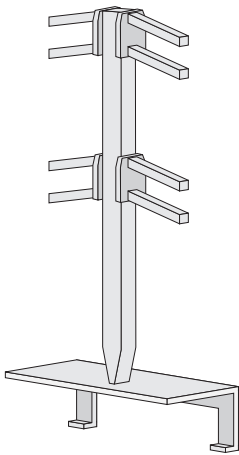

34 CONTOUR END PIN
 12/32" BI 300601
 15/32" BI 302101
 9/16" BI 303601

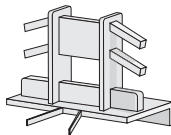

SWIGGLE GRID LOCK CLIP
 360-56GL-250 BI 221400
 360-37GL-250 BI 221300
 350ACUD-810 BI 221700

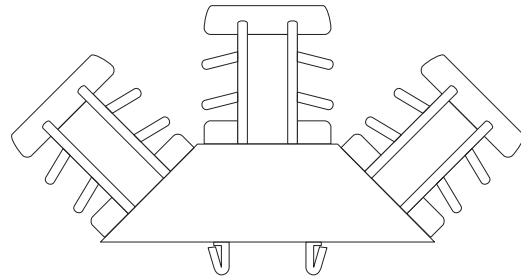

SWIGGLE STARBURST
 5.5 x 18 3 POS.
 WHT - BI 300001
 ALM - BI 300054
 CL - BI 300051

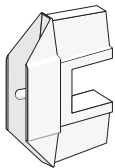

EXTRUDED SADDLE CLIP
HALF GRID 5.5 x 18
 WH - BI 275901(BI121001)
 ALM - BI 275954
 CL - BI 275951

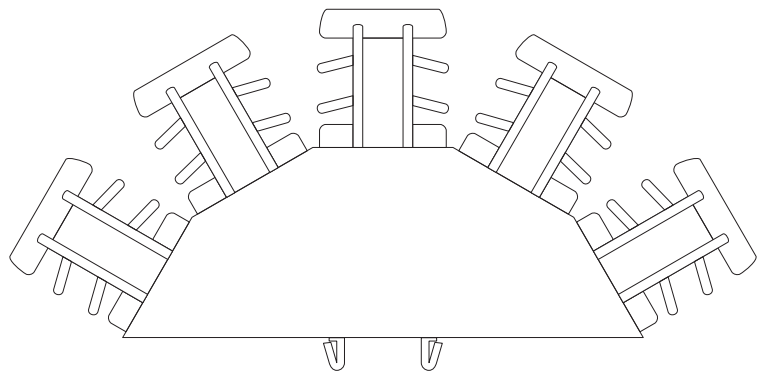

SWIGGLE STARBURST
 5.5 x 18 5 POS.
 WHT - BI 292001
 ALM - BI 292054
 CL - BI 292051

3/8" x 5/8" GRID (GOTHIC)

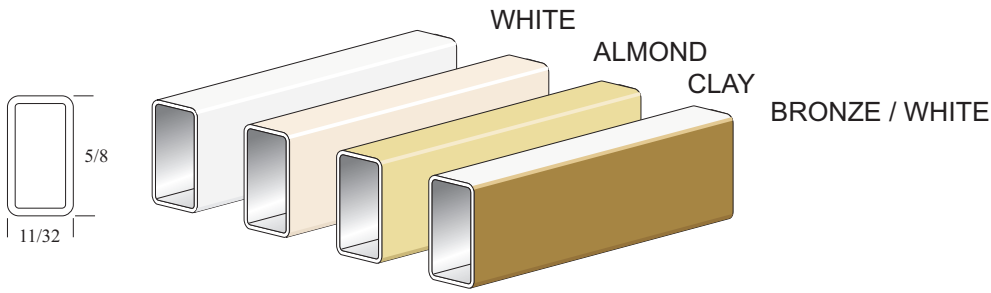

3/8" x 5/8" GOTHIC GRID
 WHT - BI241801
 ALM - BI241854
 CLAY - BI241851
 BRZ/WHT - BI241892

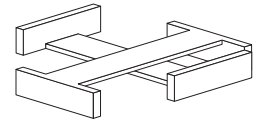

3/8 x 5/8 AIRPLANE
 BI258100

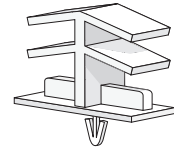

SWIGGLE FIN GRID KEEPER
 3/8 x 5/8 BI 101600

DESIGNER (PEWTER) GRID

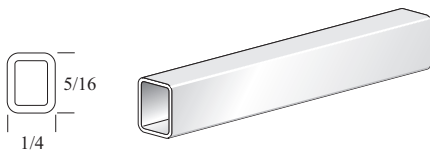

1/4" x 5/16" DESIGNER GRID
 PEWTER - BI217292

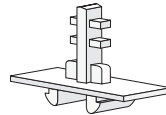

DESIGNER END PIN
 11/32" BI 261000
 15/32" BI 264600
 18/32" BI 206400
 19/32" BI 258300
 23/32" BI 206300
 25/32" BI 206500



CONCEALED JOINER
 BI253700



DESIGNER HALF GRID PIN
 BI 257900

IG ACCESSORIES



4 mm INTERCEPT SCREW
 UZ006800



4 mm CAPILLARY SCREW
 w/ HOLE
 UZ139000



CAPILLARY TUBES
 BI 224500



TOUCH-UP PENS
 (PAINT PENS)
 WHITE - BI101301
 ALMOND - BI101354

